

# Partnumbers

All measures in mm.

Cutout for DX2

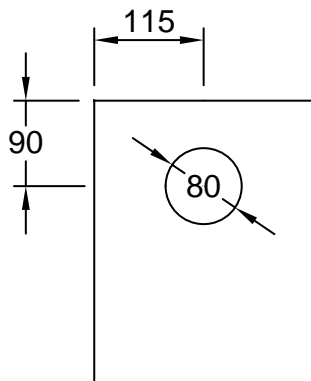
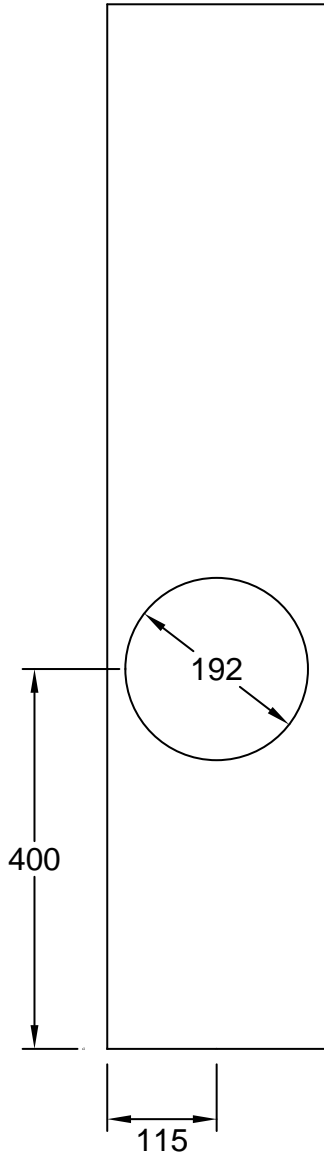

Terminal cutout in part 10.

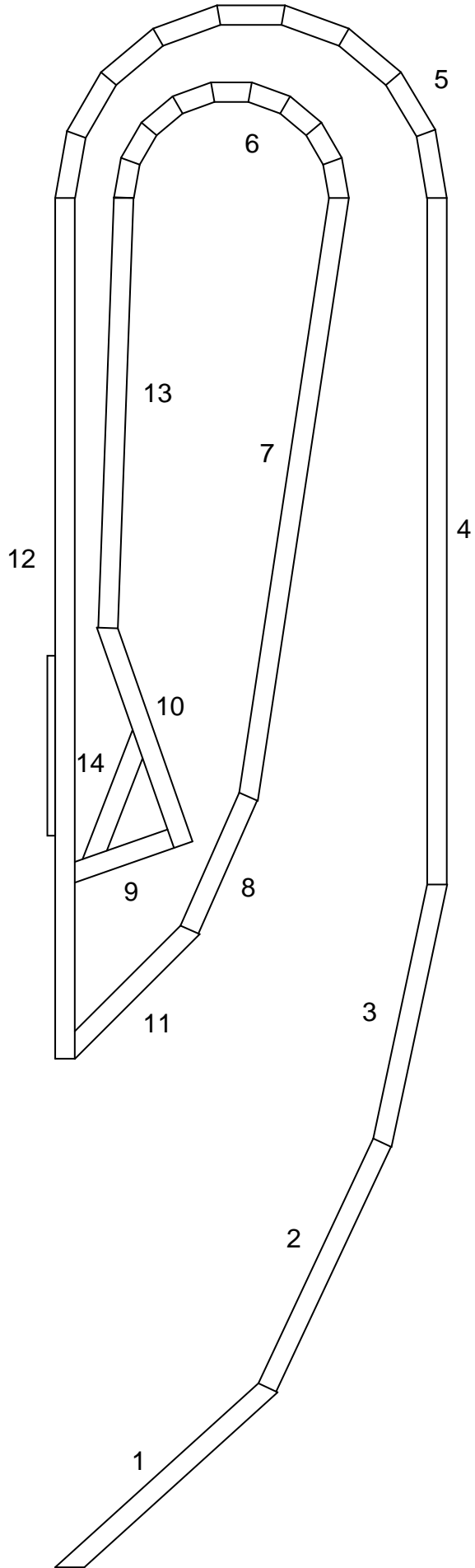

# Cornerpoints fore cutting out the sides.

All measures in mm as (X,Y)-coordinates.

Material 25 mm MDF.

- A= (0,1750)
- B= (15,1838)
- C= (58,1911)
- D= (125,1967)
- E= (206,1996)
- F= (294,1996)
- G= (375,1967)
- H= (442,1911)
- I= (486,1838)
- J= (500,1750)
- K= (101,1750)
- L= (108,1792)
- M= (130,1830)
- N= (163,1858)
- O= (203,1872)
- P= (246,1872)
- Q= (287,1858)
- R= (320,1830)
- S= (342,1792)
- T= (349,1750)

All measures with lower left corner as reference.

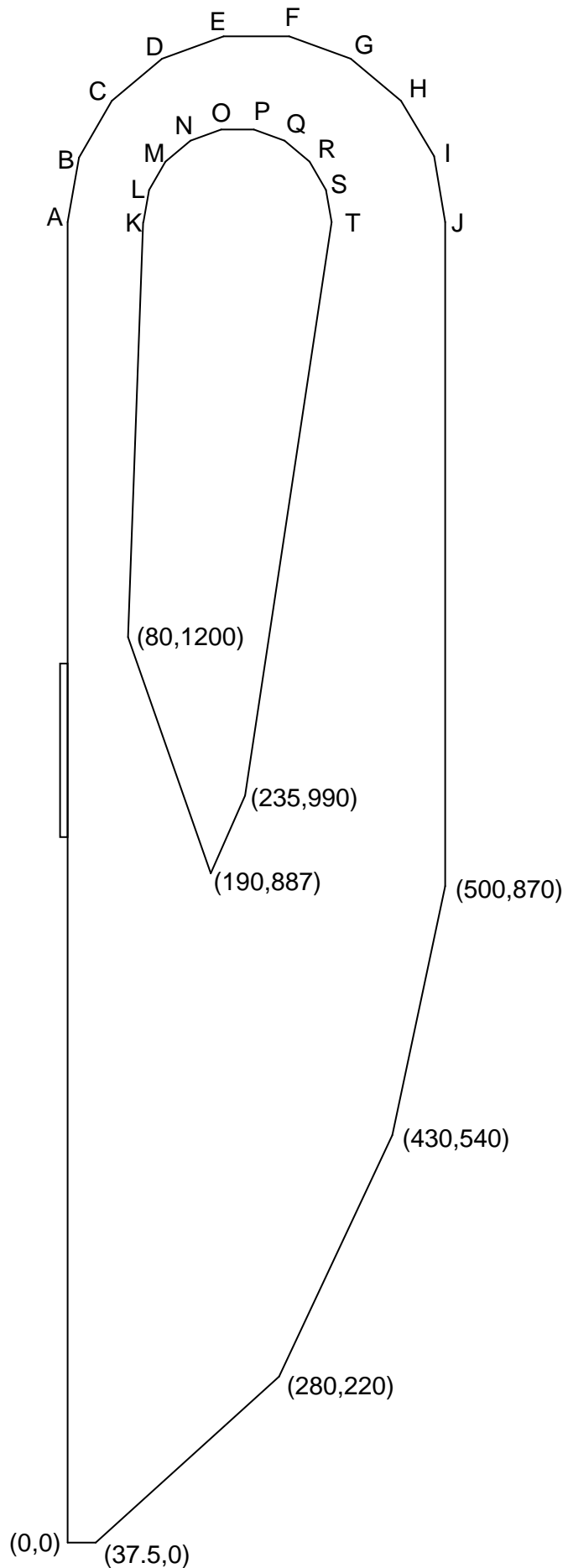

All measures in mm.

Material 25 mm MDF.

All parts 230 mm deep

One loudspeaker requires

9 pieces of part 5 and 6.

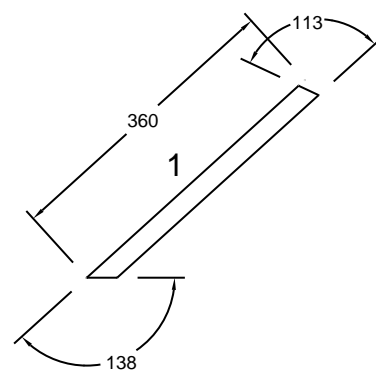
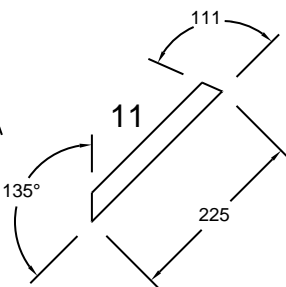
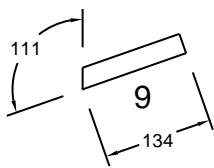
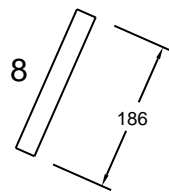
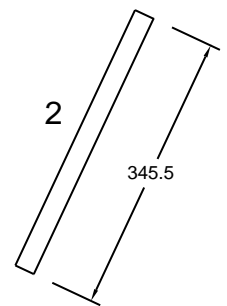
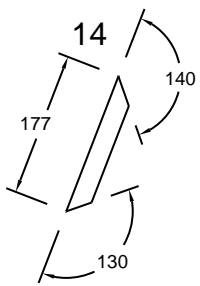
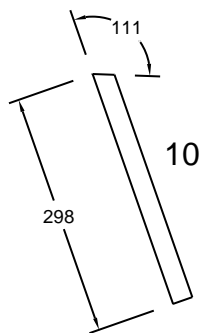
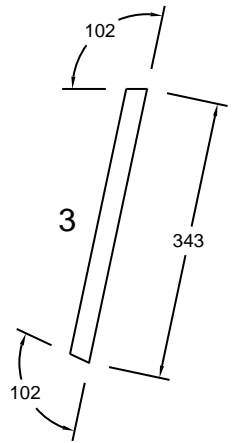
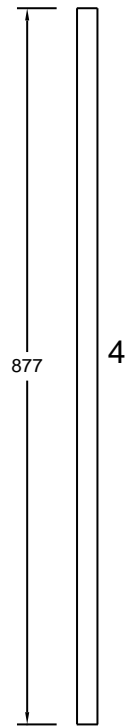
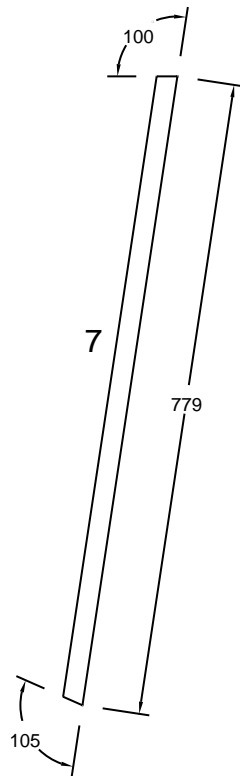
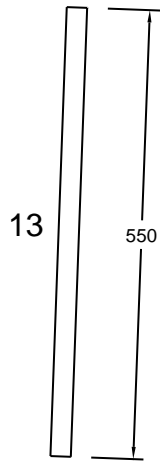
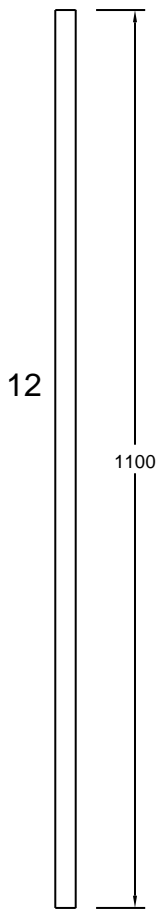
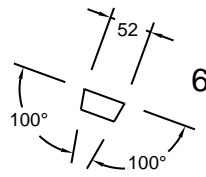
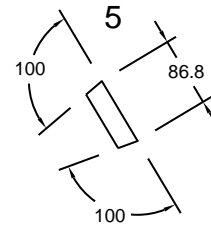

All measures in mm.  
Material 25 mm MDF.

Colored parts 20 mm wood.  
The harder wood the better.

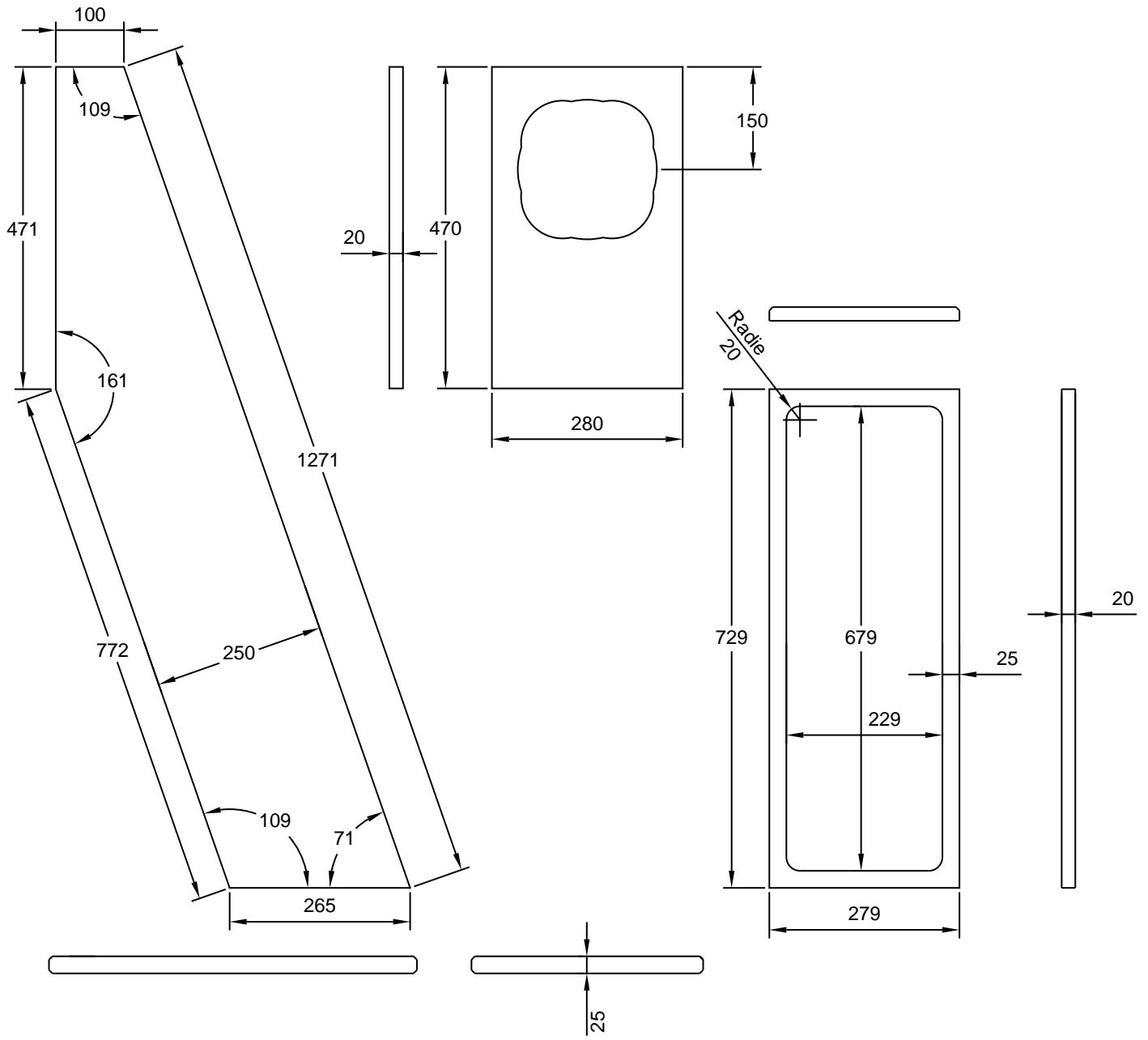

Base

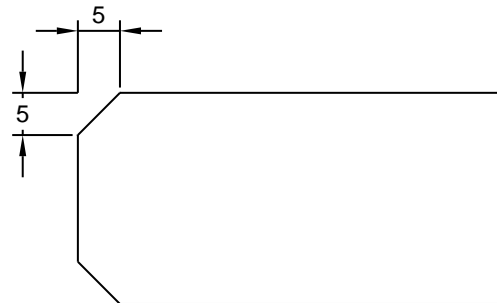
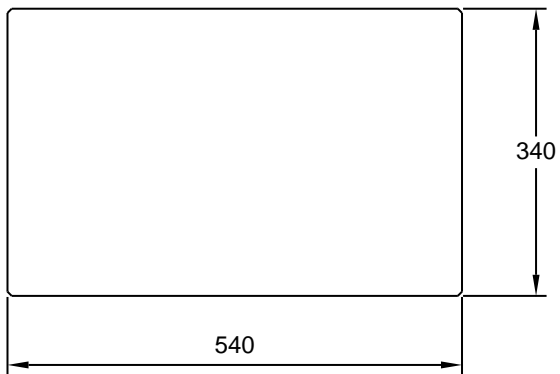

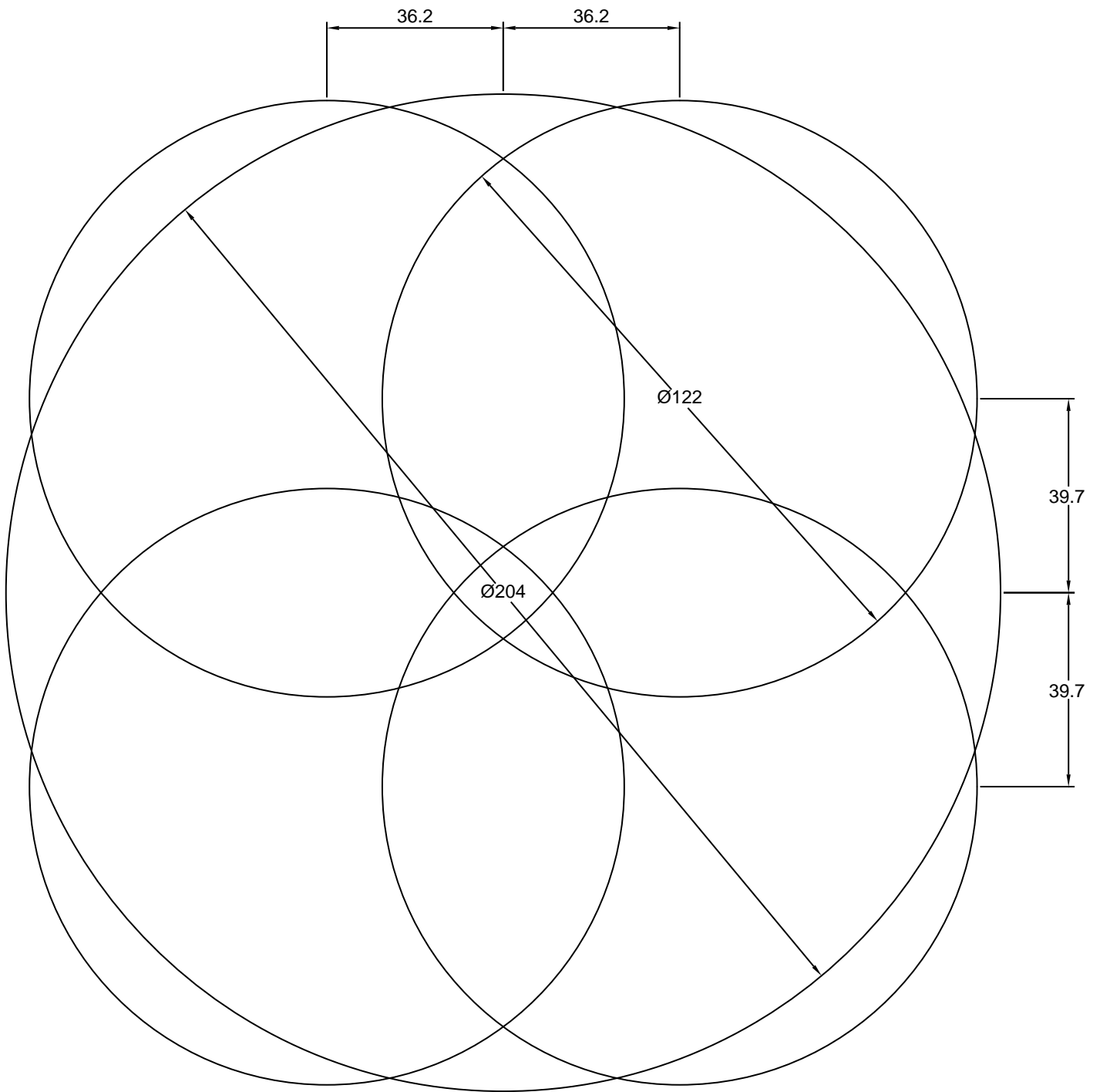

If You want Your DX2 sunken draw these circles and cut along the outer line.